

# Outline

2/4/02

[Click here to start](#)

## **Table of Contents**

**Author:** Laptop

[PPT Slide](#)

**Email:** [Roberto.Sabatino@dante.org.uk](mailto:Roberto.Sabatino@dante.org.uk)

[Outline](#)

[PPT Slide](#)

[IST Project LION](#)

[PPT Slide](#)

[Emerging Network Requirements](#)

[PPT Slide](#)

[Outline](#)

[PPT Slide](#)

[PPT Slide](#)

[PPT Slide](#)

[Outline](#)

[PPT Slide](#)

[PPT Slide](#)

[PPT Slide](#)

PPT Slide

For Further Contacts Project Leader of IST  
LION [antonio.manzalini@tilab.com](mailto:antonio.manzalini@tilab.com) Phone:  
[+39 011 2285 817](tel:+390112285817)



# IST Project LION

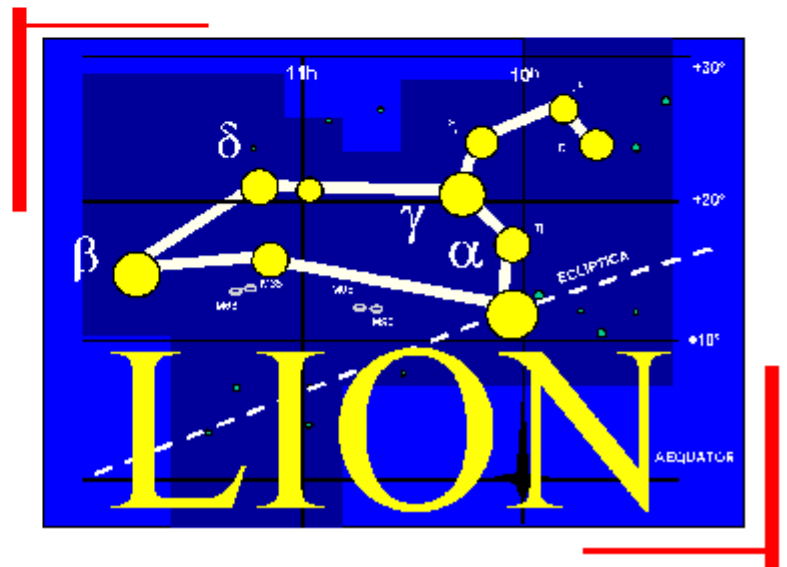

Slide 1 of 17



# Outline

- **IST-project LION**
  - **Layers Interworking in Optical Networks**
  - **Overview – objectives**
  - **Testbed**
- **Progress: 2 examples**
  - **Recovery experiments on testbed**
  - **Design of survivable multilayer IP over Optical Network**



# IST Project LION

 **TELECOM LAB** ITALIA Telecom Italia Lab - *Prime Contractor*  
[www.telecomitalialab.com](http://www.telecomitalialab.com)

 **Agilent Technologies** Agilent Technologies Italia

 **NTT** Nippon Telegraph and Telephone

 **UPC** Universitat Politecnica de Catalunya

 **National Technical University of Athens**

 **CISCO SYSTEMS**  
Empowering the  
Intelligent Generation™  
**Cisco Systems International**

 **Sirti** Sirti

 **T-Nova** T-NOVA - Deutsche Telekom

 **The University of Mining and Metallurgy**

 **imec** Interuniversity Microelectronics Centre

 **Telekomunikacja Polska**

 **SIEMENS** Siemens ICN

 **Tellium** Tellium



# IST Project LION

- **Context**
  - **Evolution of current transport networks towards next generation optical networks**
- **Main Objective**
  - **Study, development and experimental assessment of an Automatic Switched Optical Network (ASON)**
- **Project Data**
  - **Starting date : Jan-2000**
  - **Duration : 36 months**
  - **Total Cost : 10,686,236 EURO**
  - **EC Contribution : 5,499,951 EURO**



## Objectives of the Project

- **Definition of architecture and functional requirements for next generation optical networks (e.g. ASON and G-MPLS)**
- **Identification of **resilience strategies** for multi-layer networks**
- **Cost evaluation of IP over ASON solutions (case studies)**
- **Definition of a network management view for ASONs**
- **Design and implementation of two interworking Network Managers via a CORBA interface**
- **Design and **implementation of UNI and NNI****
- **Design and **implementation of Optical Control Planes****
- **Development of a **test bed IP over ASON****



# Emerging Network Requirements

- Convergence of **voice-video-data applications over the same infrastructure**
- Reduced complexity and de-layering
- Higher penetration of opt. transport services
- Flexible and cost-effective end-to-end provisioning of optical connections
- **Optical re-routing and restoration**
- Support of multiple clients (metro)
- **Multiple levels of QoS**
- **Optical Virtual Private Networks (OVPN)**





# ASON Test bed

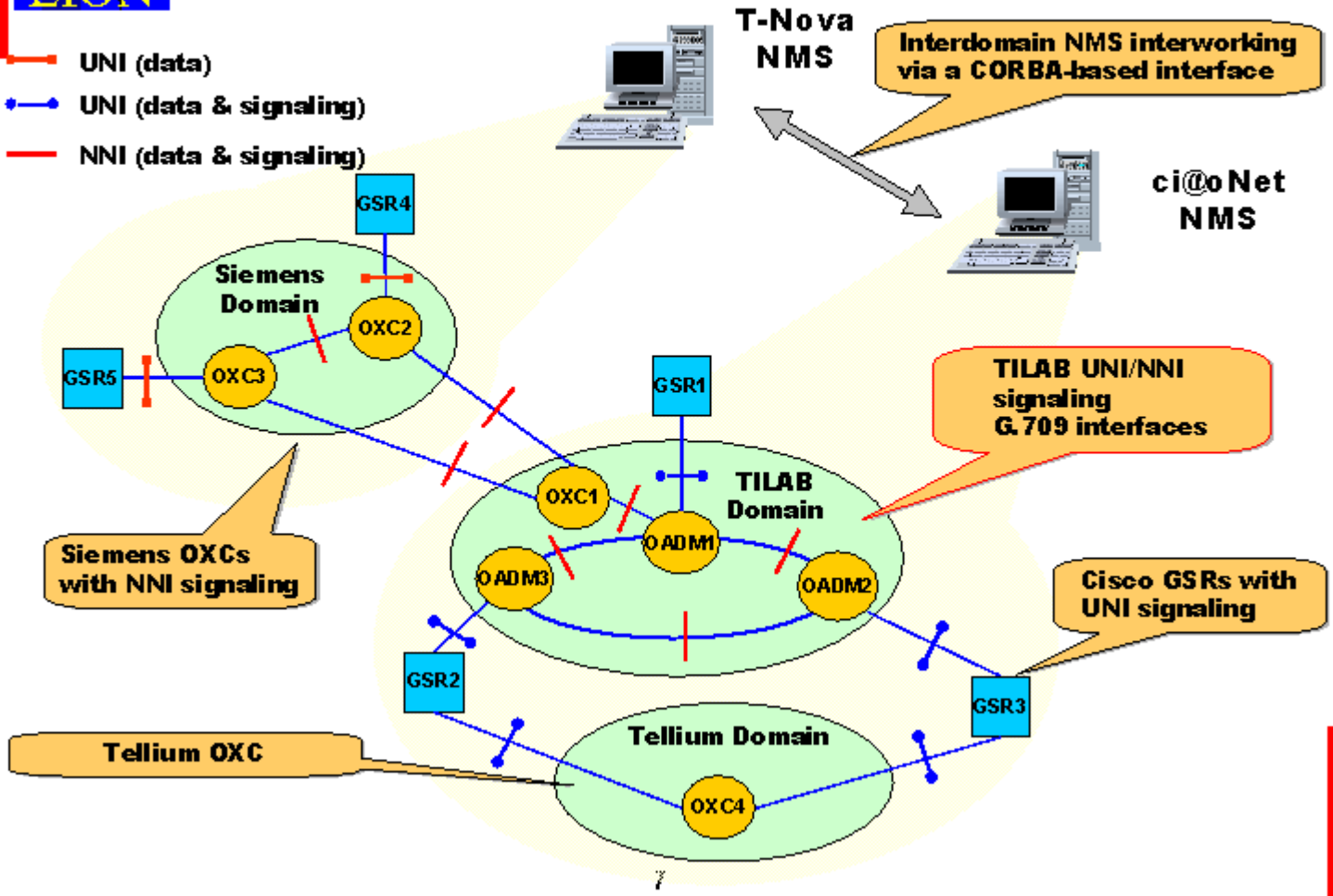



# Outline

- **IST-project LION**
  - **Layers Interworking in Optical Networks**
  - **Overview – objectives**
  - **Testbed**
- **Progress: 2 examples**
  - **Recovery experiments on testbed**
  - **Design of survivable multilayer IP over Optical Network**

# Measurements: MPLS rerouting

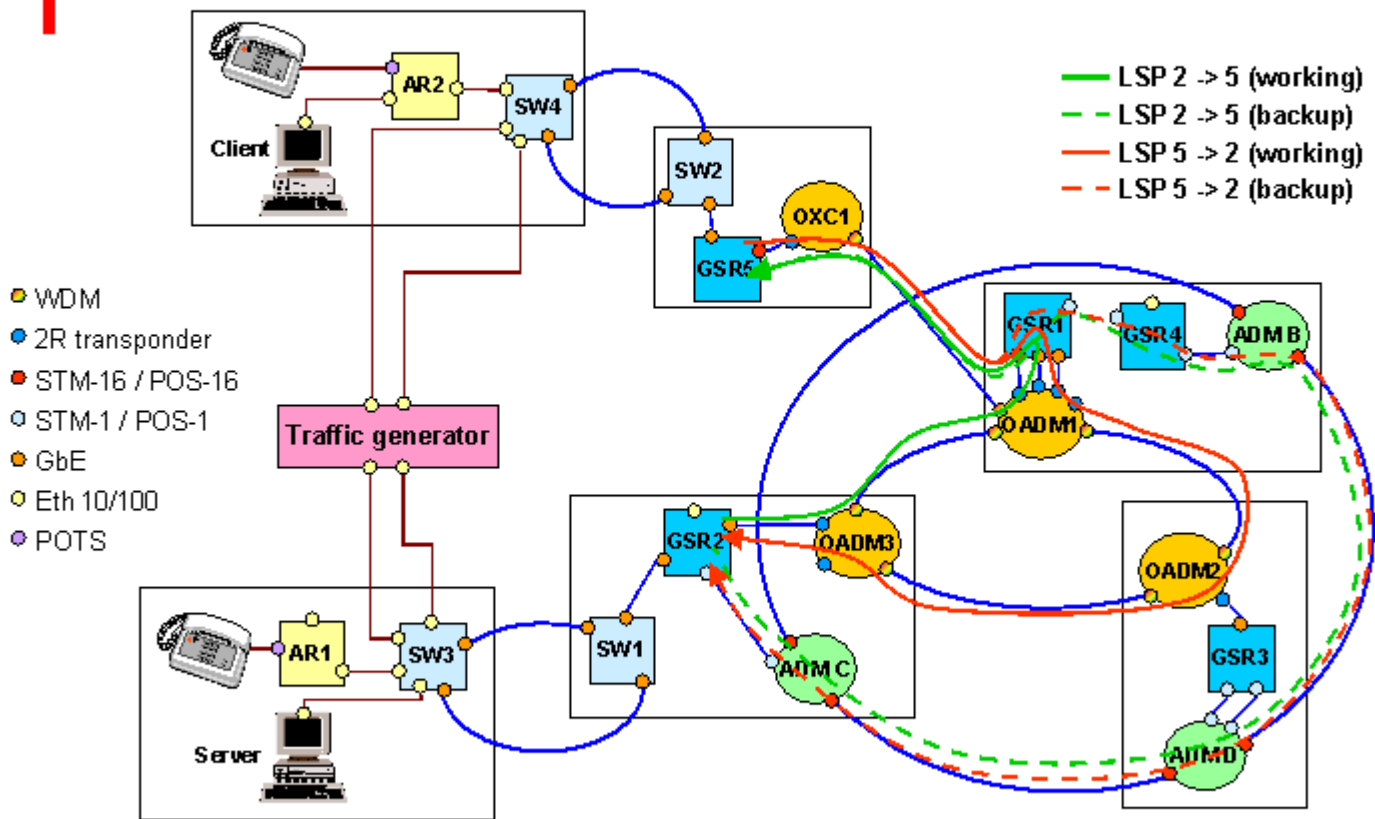

# Measurements: Optical Protection

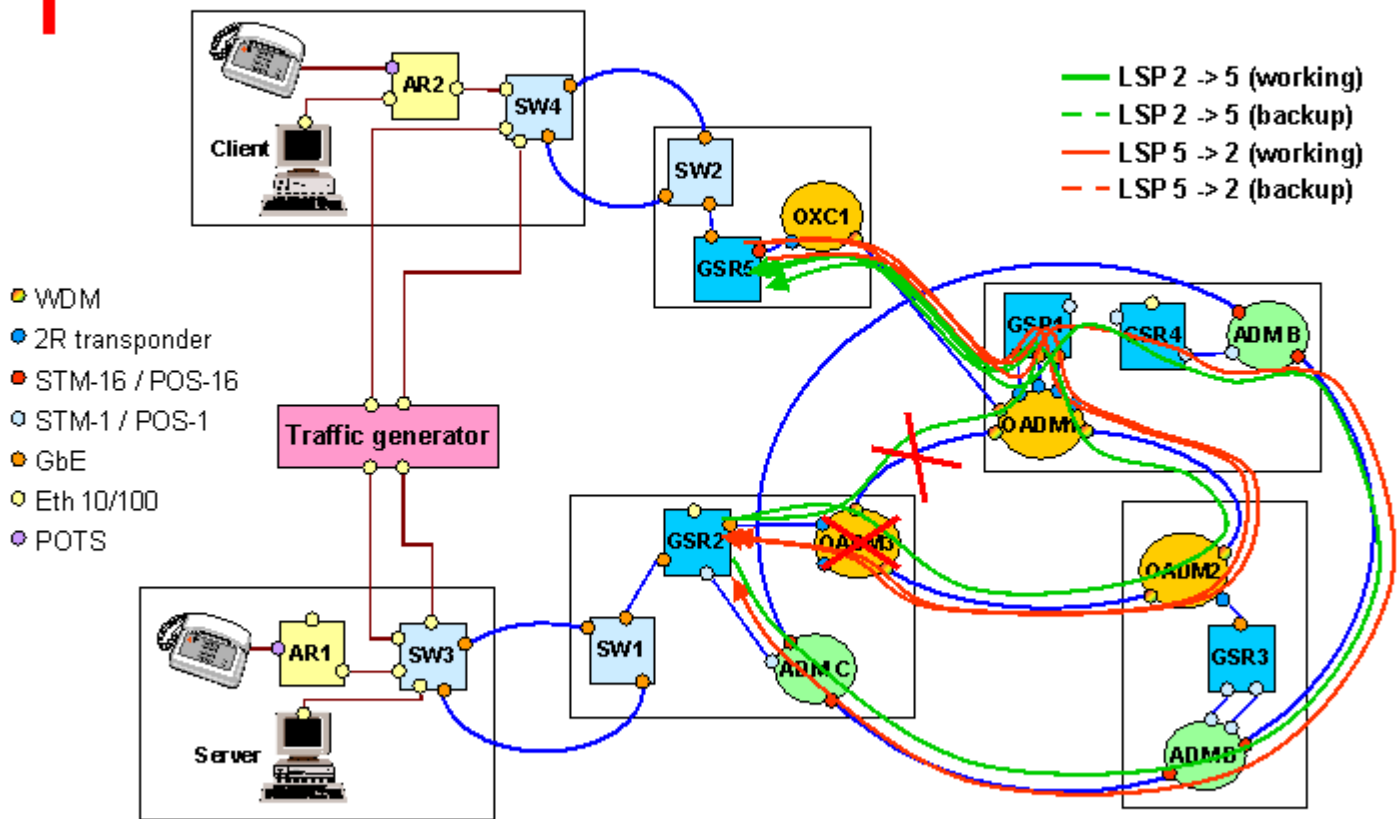



# Packet Loss Measurement

Lost Packets	Optical protection			MPLS rerouting		
	min	ave	max	min	ave	max
GSR2 → GSR5 (250 Byte)	831	936	1140	375 152	711 490	1 796 002
GSR5 → GSR2 (250 Byte)	0	0	0	321 236	378 746	574 654
GSR2 → GSR5 (1500 Byte)	190	232	353	64 131	168 622	310 154
GSR5 → GSR2 (1500 Byte)	0	0	0	45 441	73 707	122 770

≈ 25 ms

≈ 7 ÷ 39 s

GbE does not allow fast failure detection  
--> HELLO detection scheme (+/- 40 sec)



# Outline

- **IST-project LION**
  - **Layers Interworking in Optical Networks**
  - **Overview – objectives**
  - **Testbed**
- **Progress: 2 examples**
  - **Recovery experiments on testbed**
  - **Design of survivable multilayer IP over Optical Network**

# Multilayer survivability: bottom-up strategy

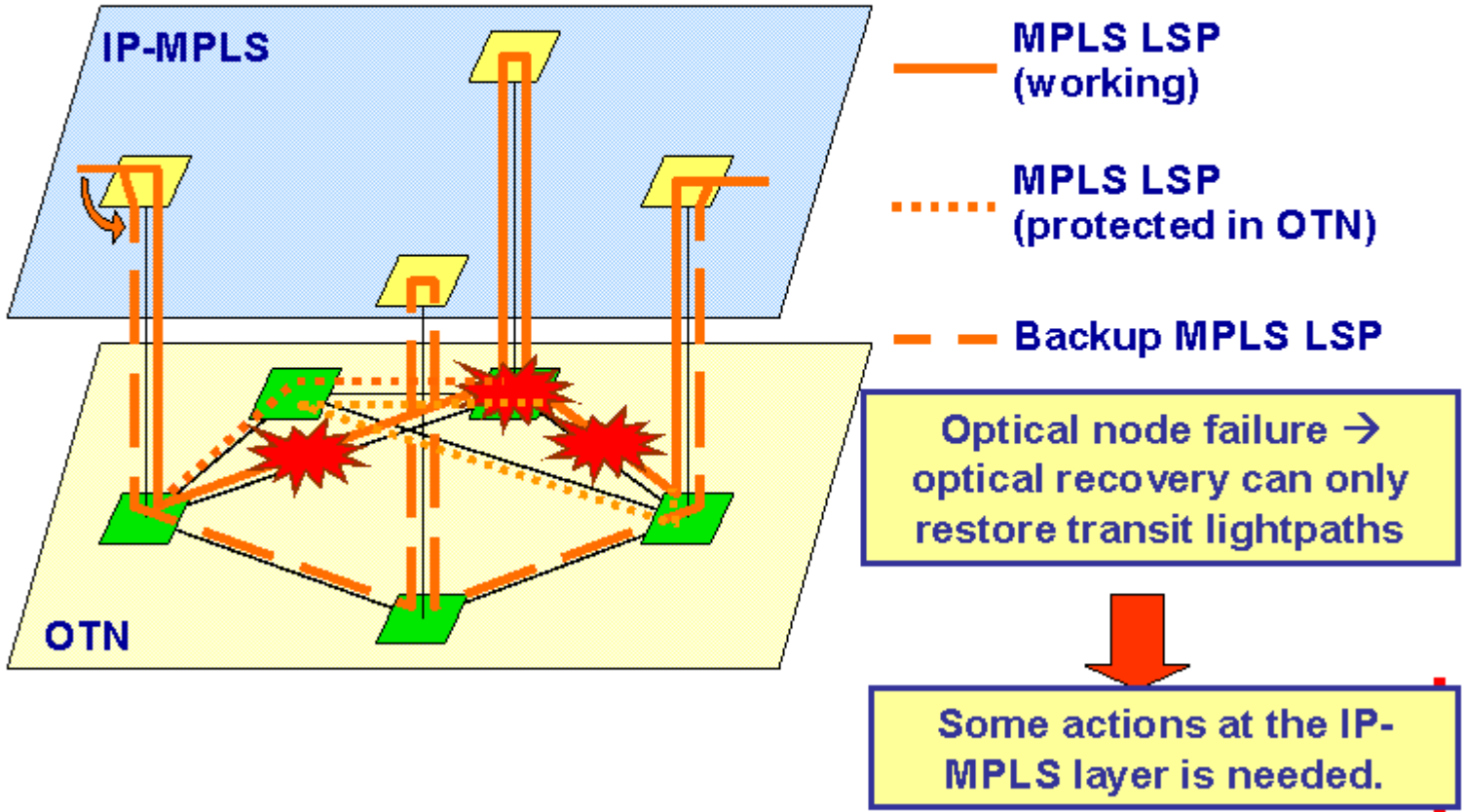

# Static recovery schemes

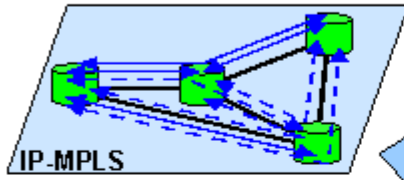

Some working and spare LSPs shown. Topology has to be biconnected to allow IP-MPLS recovery of router failures

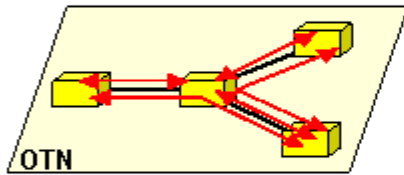

Capacity needed on OTN links

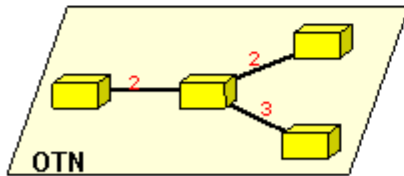

Static multilayer resilient scheme

- **Recovery scheme at the IP-MPLS layer (MPLS rerouting, local protection,...) -> IP topology has to be biconnected**
  - Assumption: MPLS rerouting
- **Recovery scheme at the OTN layer (1+1 protection, link restoration,...)**
  - Assumption: dedicated path protection
- **Multilayer scheme**
  - **Options to support IP spare capacity**
    - double protection
    - IP spare not protected
    - common pool
  - Assumption: bottom-up escalation strategy



# Dynamic ASON-based recovery schemes

- Dimensioning of multiple IP layer topologies
  - 1 for nominal (fault-free) scenario
  - 1 for each topology related with a single IP router failure

- Capacity needed in OTN is calculated for each dimensioning, taking into account capacity needed to recover from OTN failures (by means of 1+1 path protection)

- Resources needed in OTN to recover from all possible single IP or OTN failures are the worst case resource requirements of the OTN taken over the failure-free scenario and all IP failure scenarios

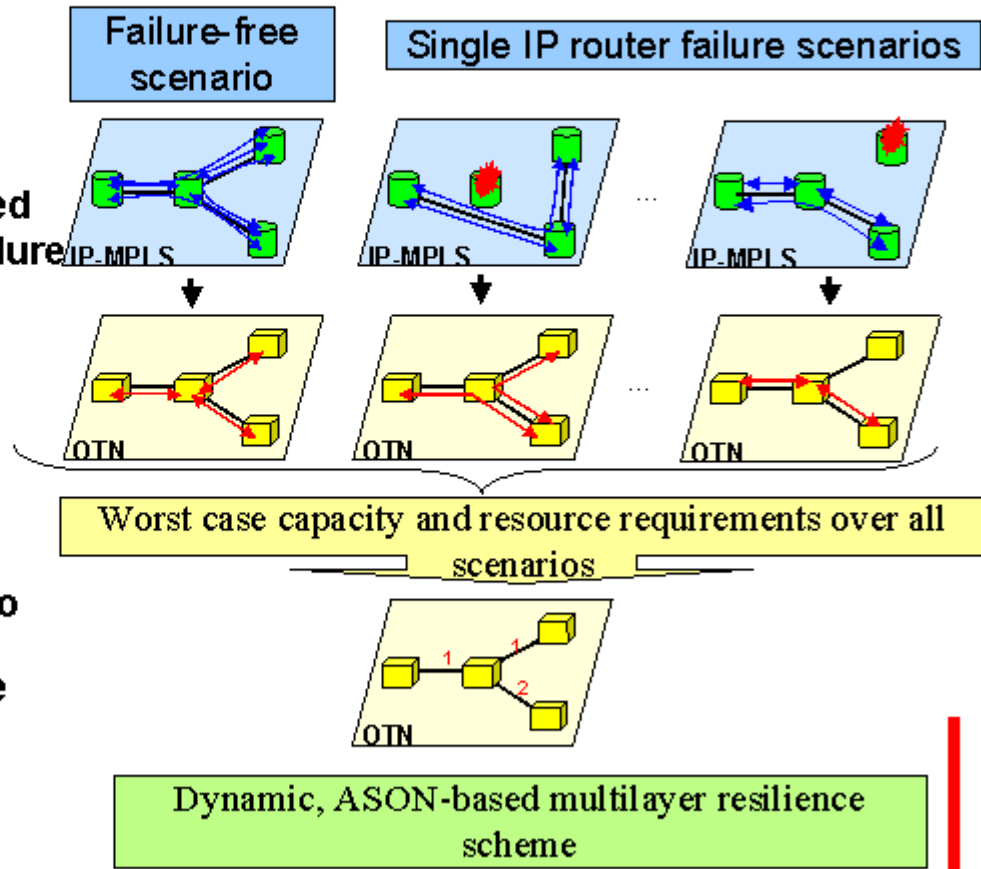

# Cost comparison

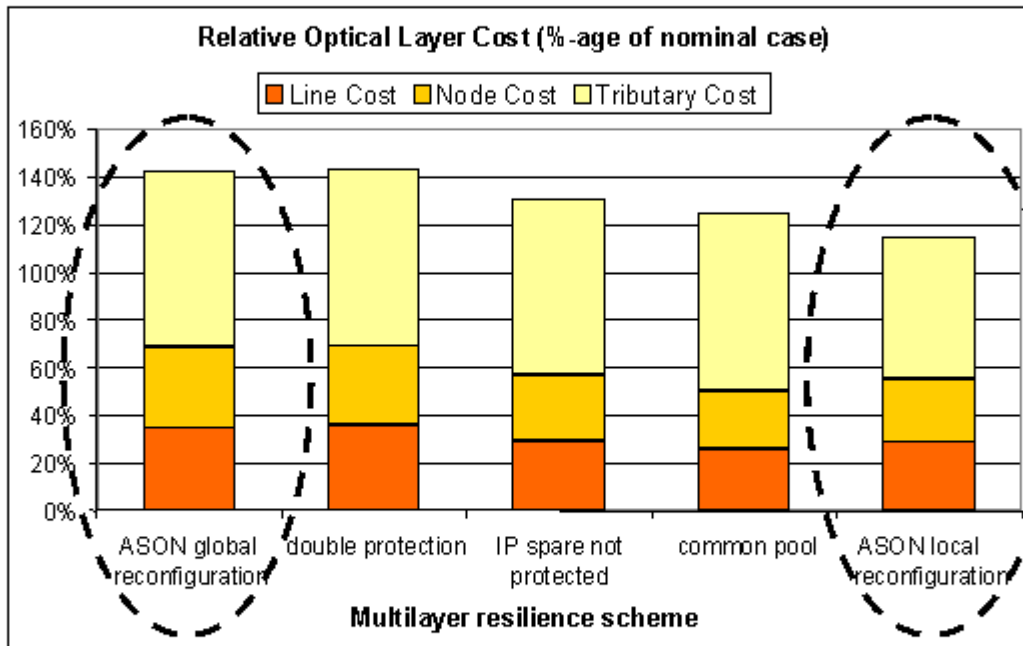

- **ASON local reconfiguration needs fewest capacity**
- **ASON global reconfiguration  $\approx$  double protection**

**Note: ASON reconfiguration schemes have better fault coverage**



# **For Further Contacts**

**Project Leader of IST LION**

**[antonio.manzalini@tilab.com](mailto:antonio.manzalini@tilab.com)**

**Phone: +39 011 2285 817**

