

TEN-155 MBS

External Operational Procedures (Draft)

QUA-99-063

OPS-99-071

Version 1

2 August 1999

(c) DANTE

Table of contents

- [Introduction](#)
- [What is TEN-155](#)
- [What is the TEN-155 Managed Bandwidth Service](#)
- [Who is responsible for the service?](#)
- [What can I ask for?](#)
- [How do I make use of TEN-155 MBS?](#)
- [Proposal stage](#)
- [Agreement stage](#)
- [Delivery stage](#)
- [Production stage](#)
- [Finish Stage](#)

Introduction

The TEN-155 Managed Bandwidth Service (MBS) external procedures are aimed at potential users of the service. The document describes the process and actions to be taken in order to become a user of the service. In order to deliver a complete picture, this document additionally gives an overview of the pan-European academic research network TEN-155 and the MBS in general. The specific MBS Service Specification is a separate document which can be found at <http://www.dante.net/mbs>

What is TEN-155

TEN-155 is a high speed network for the pan-European academic and research community. TEN-155 interconnects the national research networks (NRNs) of eighteen European countries and provides them with a high speed IP interconnect. TEN-155 provides European researchers with a core transmission network of 155 Mbps circuits and nodes in seventeen European countries. The nodes are located in Amsterdam, Athens, Brussels, Budapest, Dublin, Frankfurt, Geneva, Lisbon, Ljubljana, Luxembourg, London, Madrid Milan, Paris, Prague, Stockholm (as the connection point for the Nordic countries) and Vienna.

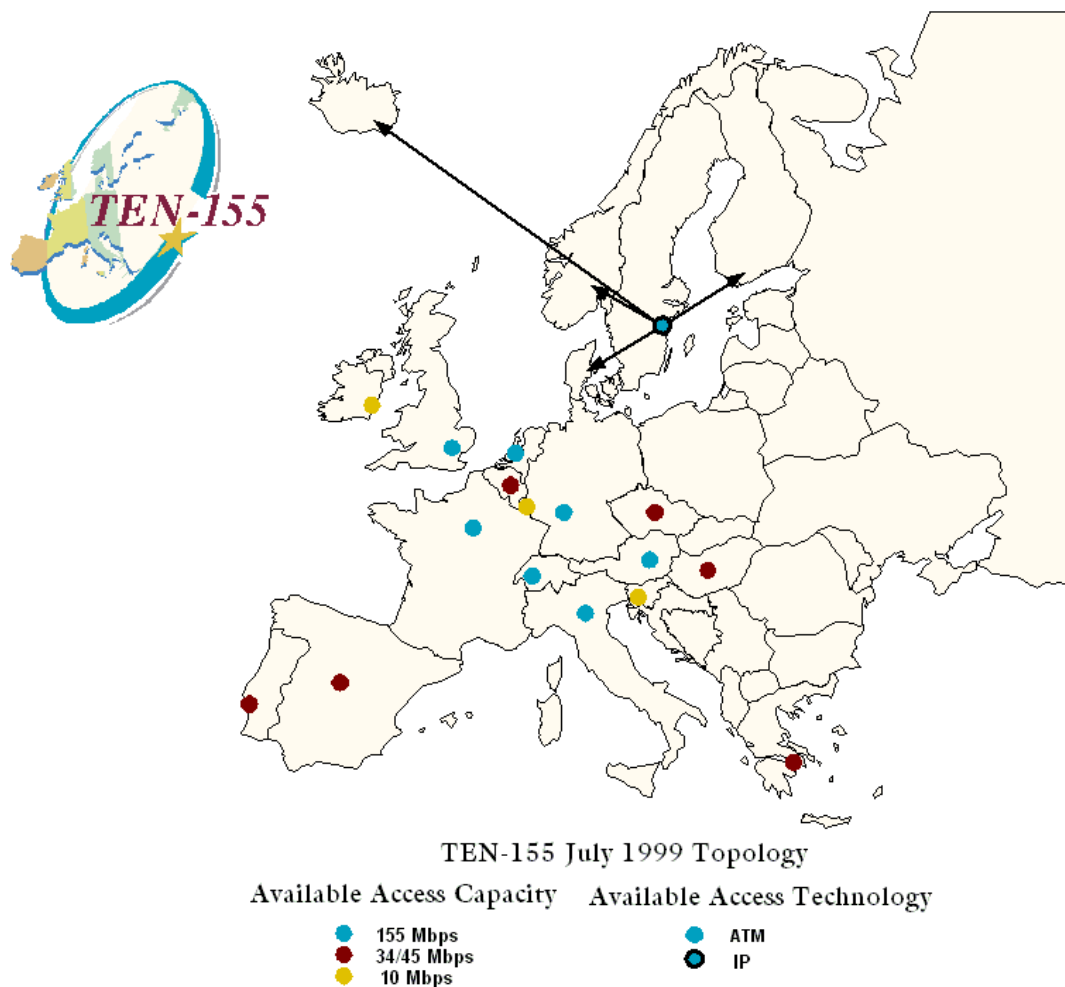

[fig 1] TEN-155 Access port map

The TEN-155 network combines the best of both IP and ATM technology. The network is based on SDH circuits with an ATM overlay which allows for bandwidth management for optimal loading of the network. The participating national research networks have the choice of ATM or Packet over SONET access to the TEN-155 network. If the access is done using ATM, different "channels" can be established and can be used for other purposes than the main IP interconnection.

The map in figure 1 describes the access technology and capacity for national research networks connected to TEN-155.

The ATM overlay of the TEN-155 network allows for the provision of virtual channels (VCs) with specific bandwidth reservation and guarantees between the participating national research networks. This forms the basis for the provision of the Managed Bandwidth Service.

What is the TEN-155 Managed Bandwidth Service

The TEN-155 Managed Bandwidth Service enables connectivity among research projects in countries connected to TEN-155. ATM connections are established between project participants' sites, creating in this way a virtual private network based on ATM.

For such a virtual private network (VPN) to be created, all participants' sites must have an ATM port available and must be able to provide an end to end connection via the NRN ATM infrastructure.

Alternatively, a direct connection between the project ATM port and TEN-155 can be made using any ATM carrier network.

Figure 2 identifies the different network equipment involved (Routers, ATM switches) and the ATM links to be established when the connection is made directly to a TEN-155 port (located in the national TEN-155 Point of Presence) or when the NRN ATM network is used to provide transport between the project port and TEN-155 port. In this case the TEN-155 port acts as the demarcation point between the national and the international paths.

The routers if fig 2 are used for the IP service provided over TEN-155, they are not involved in the TEN-155 MBS service since only ATM level links are used.

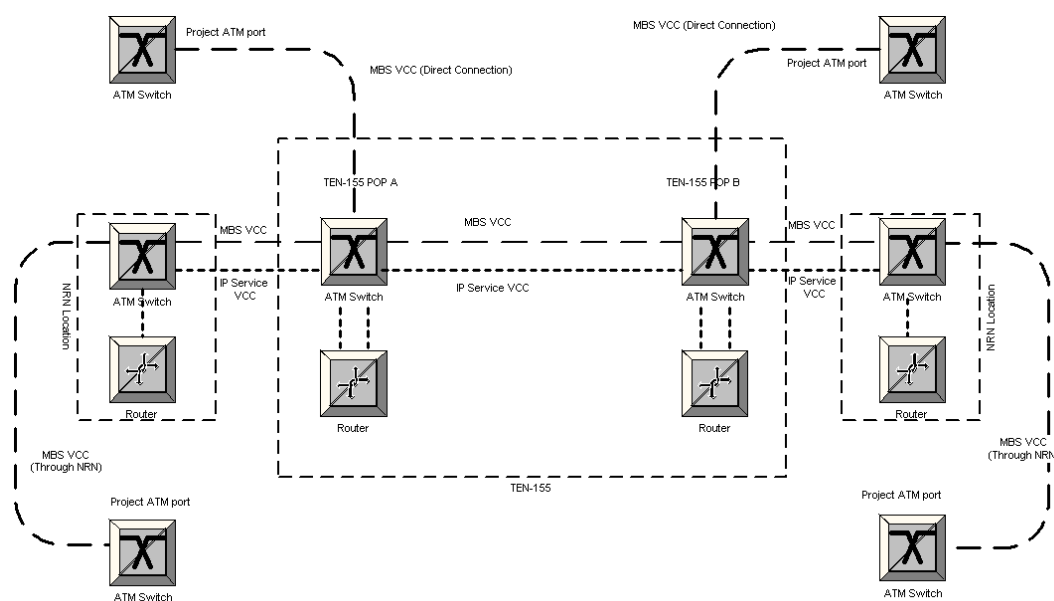

[fig 2] TEN-155 MBS Architecture

The direct connection is subject to acceptance from the NRN management and the resources needed to establish the interconnection up to the TEN-155 equipment are to be provided by the project.

MBS may use existing network resources of those national research networks, connected to TEN-155. An initial guideline is allowing 10% to 20% of the existing bandwidth between a national research network and TEN-155 to cater for Managed Bandwidth Service requests.

MBS is an end-to-end service. Its availability depends not only on the TEN-155 network but also on the NRN network infrastructure and the existing technical and human resources within the participating national research networks.

There are similar services in some national research networks connected to TEN-155, DFN and SURFnet have their operational national ATM service, UKERNA is piloting their National Managed Bandwidth Service based on SuperJANET and some other networks are developing similar services on a nation-wide basis (GRNET, RENATER-II, BELNET, RCCN). For an overview of existing services, refer to <http://www.dante.net/mbs/nrn/matrix.phtml>.

Who is responsible for the service?

Connecting the European sites of a project means establishing international links which make use of resources of at least two different NRNs (national paths) as well as of the international TEN-155 backbone (international path).

Since NRNs are responsible for the national path, a representative (ATM Service Manager - ASM) must authorise the usage of the network for transit. For the international path DANTE is the responsible organisation acting on behalf of the TEN-155 consortium and will also co-ordinate interaction with ASMs for authorisation and other purposes. The co-ordination will be limited in those cases where a similar service to the TEN-155 MBS exists and national procedures require the project to contact the NRN directly.

Use of MBS from NRNs is subject of the same acceptable use policy as for the IP service. If a NRN accepts a service request as part of a project but is not in a position to provide the required national path then connections may be established directly between network equipment belonging to the project and those of the TEN-155 network. In that scenario, national transit and access to the TEN-155 Point of Presence is the responsibility of the project.

Whether or not the NRN is the provider of the national path, its ASM must agree to give access to the TEN-155 network by the project.

What can I ask for?

The definition of the end-to-end connection depends on the availability of the requested options all along the path through several different administrative domains between end points. Not all the ATM networks involved in European research and academic networking have the same architecture, nor are they based on the same technology or managed in the same way. This means that available options for connections (bandwidth granularity, scheduling, etc) depend on the availability of the requested option in all domains between the end points.

Information about the characteristics of ATM networks and service in different NRN is provided at <http://www.dante.net/mbs/nrn/matrix.phtml>. This is a changing description and must be considered with caution. Refer to the electronic addresses given as the source of fresh information.

If the connection is established between the NRN and the project, the type of interface and the software/hardware specifications depend on the existing and available equipment deployed by the NRN. Technical issues should be solved on a case by case basis.

If the connection is established directly between projects and the TEN-155 network, the project is responsible for providing the necessary resources for access, including an installation charge to cover costs of deploying extra ports. The demarcation point is the patch panel to which the TEN-155 ATM switch is connected; DANTE is responsible for the connection from the patch panel to the switch.

Subject to the general limits specified below, the maximum capacity of a link is around 30Mbit/s in

best conditions. In principle, links with capacities of any value up to this maximum can be established.

Overall limits to allocated resources exist to prevent network "hogging". These initial limits, subject to revision during the evolution of MBS, are implemented by restricting total usage between TEN-155 user access ports to:

- No more than 10 concurrent VCC/VPC through any TEN-155 user access port.
- The routing of the connections will be based on network engineering judgement considering the available bandwidth and the usage patterns.
- The maximum amount of bandwidth allocated at any one time at any NRN access port shall be no more than 20% of the access capacity.

For the direct links, the following interfaces are supported:

- E3 (electrical, G.703)
- T3 (electrical, G.703)
- E1 (electrical, G.703)

Support for the following elements has been built into the TEN-155 backbone:

- PVCs and SVCs, looking on how the connection is established and released:
- Occasional, permanent and periodic connections, depending on the duration of the connection (PVCs only):
- VCs or VPs, depending on the ATM type of connection:
- Point to point or point to multipoint, depending on the number of end points:
- DBR, SBR2, SB-3 and ABR (CBR, VBR, UBR and ABR in ATM forum), depending on the requested transfer capability (with specifications according to standards ITU I.371, ITU I.356)

[fig 3] Technical details of supported interfaces and ATM connection types

How do I make use of TEN-155 MBS?

Potential users of MBS are distributed research projects and connected universities and research institutions, as well as European organisations participating in EC co-funded research and development activities with sites in countries of participating NRNs.

Access to MBS is based on the establishment of ATM connections between network equipment belonging to or used by one of the project members and network equipment of the NRN or the TEN-155 network. Having the project participant sites already connected as part of national research networks, or in a position to connect in a short period of time, is a strong requisite.

DANTE will act as a co-ordinator in the process of setting up the network, establishing contacts with the ASM and making sure that all involved persons in the project have the correct information.

Organisations participating in a project must identify a Group Network Manager (GNM) whose role is the co-ordination of all the members in the project and communication with DANTE. The GNM should have a good knowledge of networking and the networking needs of the project and/or strong project management skills to co-ordinate the flow of information between the technical contacts, DANTE and the ASM.

The primary channel of communication is between the GNM and DANTE. DANTE will contact the responsible persons of the NRNs involved and will stay in constant contact with the GNM, as the single contact point to the project.

Most if not all of the contact will be done using electronic mail and web tools. The initial contact address is mbs@dante.org.uk, and more information is available on <http://www.dante.net/mbs>

An overview of the TEN-155 Managed Bandwidth Service workflow is illustrated in figure 4, where 5 main stages are identified: Proposal, agreement, delivery, production and termination.

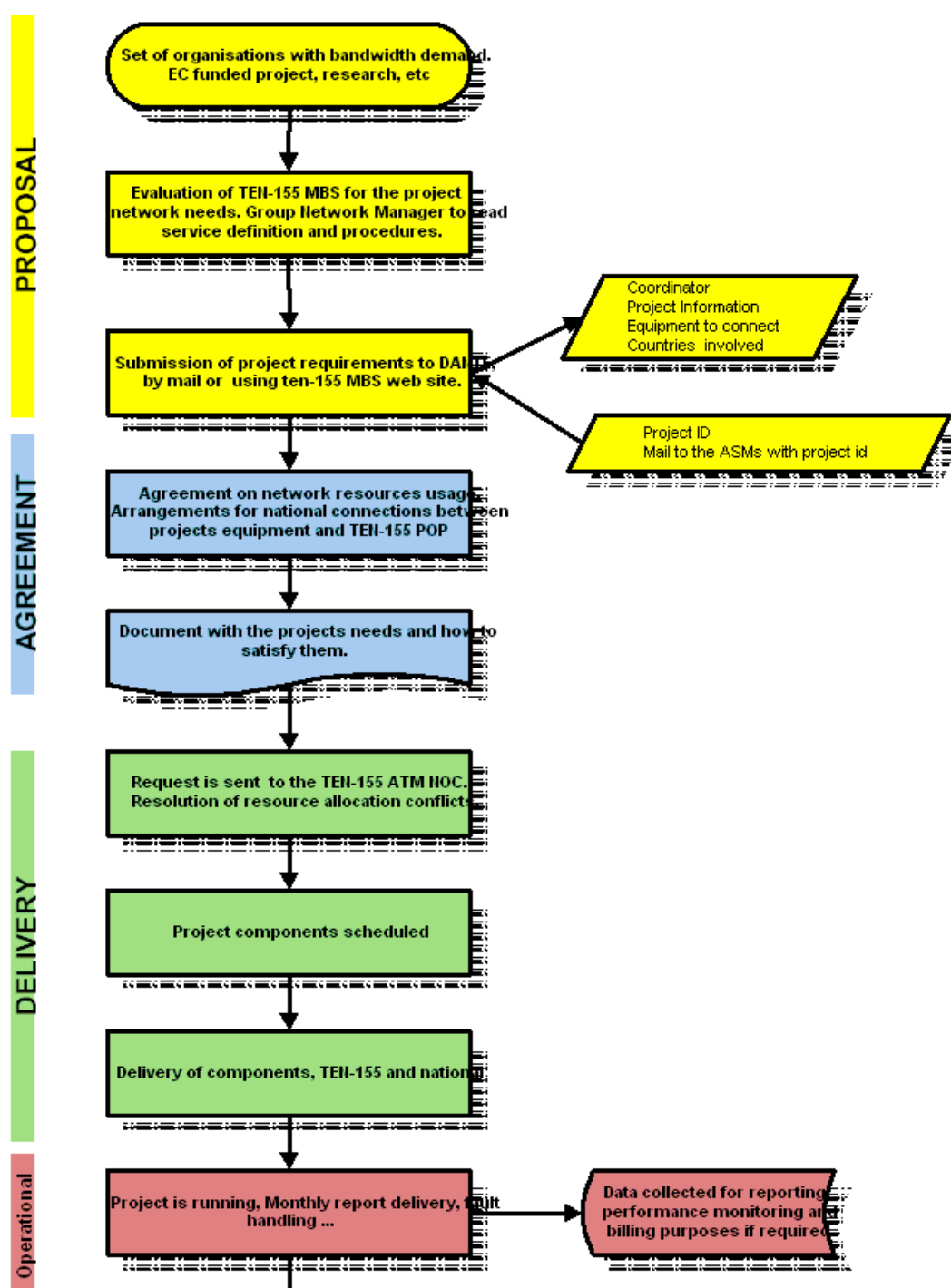

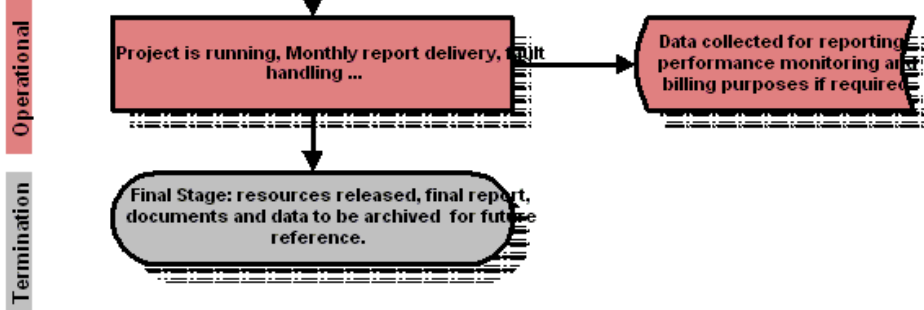

[fig 4] TEN-155 MBS Workflow

Proposal stage

In this phase, the project Group Network Manager collects information about the project sites and the suitability to use TEN-155 and the NRN as the transport network. It is important for the project requirements to match the service description, that can be found in the dante web site.

To make the initial request the Group Network Manager sends DANTE (mbs@dante.org.uk) a description of the project and information about the project planned network, including a minimum set of information aimed to help evaluating the project feasibility, the amount of resources needed and a references for calculating costs in case additional equipment or resources are necessary. Electronic mail or web based tools (located under <http://www.dante.net/mbs>) will be used for this initial contact.

The initial contact from the project must include:

- A short description of the project, and the framework in which it is running.
- A list of participant sites in the network, including country, contact persons information and the connectivity status regarding the NRN
- The name, e-mail address and phone number of the person that will act as the Group Network Manager, and a backup person if possible.

A proposed template example, to be used as a reference, is provided in figure 5.

Project Name:	RASMUS
Project description:	Remote Access Multimedia User Support
Organisation:	DANTE
Group Network Manager name:	Jose Manuel de Arce
Group Network Manager email:	jose.arce@dante.org.uk
Group Network Manager phone:	+44 (1223) 302 992
Backup GNM name:	-
Backup GNM email:	-
Backup GNM phone:	-
Site name:	UK Branch, London
Country:	UK
Technical contact name:	Jose Manuel de Arce
Technical contact email:	jose.arce@dante.org.uk

Technical contact phone:	+44 1223 302992
Admin contact name:	same as technical
Admin contact email:	same as technical
Admin contact phone:	same as technical
Site name:	French office, Paris
Country:	FR
Technical contact name:	David Harmelin
Technical contact email:	david.harmelin@dante.org.uk
Technical contact phone:	+44 1223 302992
Admin contact name:	same as technical
Admin contact email:	same as technical
Admin contact phone:	same as technical

[fig 5] TEN-155 MBS Project and site example

The first block describes the project, identifying the name, purpose and important contact information. The following blocks give information about the sites that are participating and will become nodes in the network. As a result of this preliminary contact, the whole project will be evaluated by DANTE, consulting the involved NRNs when necessary or referring to existing national services information. The final goal of this phase is to make sure that the requested network can be implemented in a convenient way and will fulfil the project needs. As a result of the proposal, the project will be assigned a name and all the involved NRN ASM notified. This is the "official" start date for project implementation.

Agreement stage

After the project is evaluated as feasible, DANTE will produce a network topology diagram in which the different elements constituting the network will be identified:

- A list of all the ATM Permanent Virtual Circuits (PVCs) needed.
- The information needed to request the PVCs in the different NRNs, following national procedures, if existing, or contacting the ASM.
- A list of actions for the Group Network Manager (GNM) and DANTE to do in order to progress the project, like establishing contacts with national research networks similar services and get acceptance of the project.
- A web based public point of information about the evolution of the project and information for participants

In the example of the template, the (simple) network topology is:

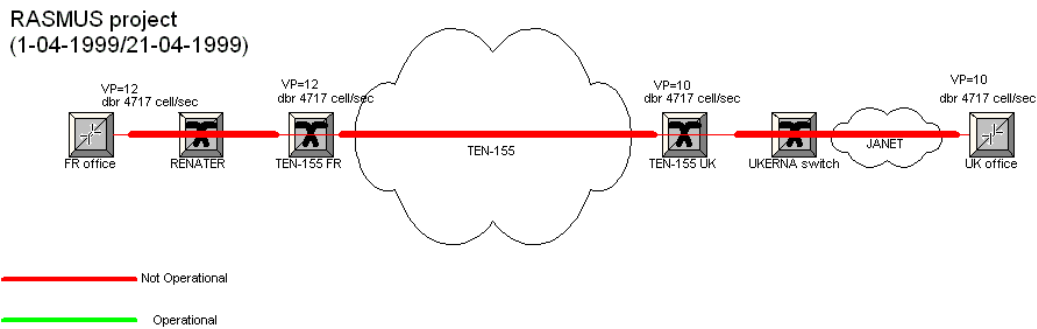

[fig 6] Initial network topology

The ATM PVCs involved in the network are:

- PVC between the French office ATM interface to RENATER's interface with TEN-155 in Paris
- PVC between Paris and London across TEN-155
- PVC between the TEN-155 port in London and the ATM port of the DANTE office connected to SuperJANET in Cambridge.

For identifying resources that the NRNs have to provide within their national networks, the following elements of information will be gathered for those countries in which the co-ordination is done BY DANTE. The Group Network Manager is responsible for information gathering and distribution within the project.

First of all is the identification of the ATM port that the project is going to use for its connection with the NRN ATM network. A template that includes all this information elements is depicted in figure 7.

```

Project Site:

Tech contact: (the one in control of ATM config)
  Name
  Address
  Phone
  Fax
  Mail
  NOC-mail (for outages and troubleshooting)

Admin Contact: (the one "owning" the port)
  Name
  Address
  Phone
  Fax
  Mail

ATM port:
  Equipment code (if existing)
  Address (ATM/IP?)
  
```

```

Location:
  Address
  Room
  Rack
  Connectors positions
Vendor information:
  Vendor
  Model
  Hardware/software revision
  Features

Remarks:

```

[fig 7] TEN-155 MBS Project site technical details

This information is per site. It gives DANTE and the NRN ASM all the needed information to identify the equipment and configure the PVCs. It also helps in case of problems and supplies information about specific characteristics like limits in values for VP range, etc. The information describes the end equipment that the project plans to connect to the NRN, or via an intermediate service provider. This equipment must be under management of the project member.

Following the example, the information provided by the participants is:

```

=====
QUANTUM MBS (beta test),      PVC  UK-FR
=====

Project Site: DANTE offices, Cambridge, UK
-----
tech contact: (the one in technical control of ATM config)
  Name      Jose Manuel de Arce
  address   Francis House, 112 Hills Road, Cambridge, UK
  phone     +44 1223 302992
  fax       +44 1223 303005
  mail      jose.arce@dante.org.uk
  NOC-mail (for outages and troubleshooting):
            operations@dante.org.uk

Admin Contact: (the financial responsible for the equipment)
  Name      Jose Manuel de Arce
  address   Francis House, 112 Hills Road, Cambridge, UK
  phone     +44 1223 302992
  fax       +44 1223 303005

```

mail jose.arce@dante.org.uk

```
ATM port: (The interface with the NRN, under project control)
Equipment code (if existing)      CISCO LS1010
Address (ATM/IP?)
  ATM  44.211f.4100.0010.0000.0001.0004.4444.2222.11
  IP   -
Location:
  Address                          Francis House, 112 Hills Road,
                                   Cambridge, UK
  Room                             "Computer Room"
  Rack                             "Rack 1"
  Connectors positions             ATM-Port 1/1/0
Vendor information:
  vendor                           CISCO
  model                            LS1010
  hardware/software revision       HW:  ASP/FC1
                                   SW:  11.2(8)WA3(3)
  features                         Per flow Queuing
  remarks                          The interface is multimode.
```

[fig 8] TEN-155 MBS Project site information example

The last piece of information needed describes the traffic parameters. It will serve to establish the configuration of equipment. If those parameters are not known when the request is done, they need to be identified (and agreed) in the discussions that will follow the acceptance of the project. The most important parameter here is some approximation of the amount of traffic, just for initial planning purposes. Bandwidth and time are limited resources, therefore this information is very important for evaluating the initial request and answering the question of "Do we have that amount of resources in that period of time?"

PVCs and Time slots:

```
Origin (Port@site):
End (port@site):
from (UTC time):
to (UTC time):
Periodic? (period specification)
Usage (purpose, video, IP, best effort, etc)
VPi or Vci: {VP/VC}
  vpi (local/remote)
  vci (local/remote)
ATM traffic capability: {dbr/sbr2/sbr3}
  pcr (forward/backward) cells/seg
```

```
src (forward/backward) cells/sec
mbs (forward/backward) cells/sec
BW in mbits/sec (generic requirement) (forward/backward)
Comments on config (origin/end)
```

[fig 9] TEN-155 MBS PVC and timeslots template

In the example, the requested PVCs with their schedule information are:

PVCs and Time slots:

```
Origin (Port@site):      Cisco-LS1010, Port4/1/0, DANTE Cambridge
End (port@site):        FORE-ASX200BX, Port 1B2 DANTE Paris
from (UTC time):        01.04.99  10:00 CET
to (UTC time):          21.04.99  10:00 CET
Periodic?               full time
Usage (purpose)         IP
Vpi or Vci              VP
vpi (local/remote)     local (UK ):10 remote (FR): 12
ATM traffic capability:
  dbr/sbr2/sbr3        CBR (dbr)
  pcr (forward/backward) (forw = backw) 4716 cells/sec
  src (forward/backward) -
  mbs (forward/backward) -
  or
  BW in mbits/sec      above info means CBR, 2 Mbit/s (fw=bw)
Comments on config (origin/end)
```

[fig 10] TEN-155 MBS PVCs and time slots example

This information will be elaborated to produce a network plan that will be submitted and discussed with the ASMs. The network plan agreement phase has the objective of producing the final specification for the network to be provided and used by the project. In this stage conflicts due to insufficient bandwidth in some ports of equipment limitations, or scheduling problems will be solved.

Once the project feasibility has been verified, necessary arrangements may be made directly between ASMs and the Group Network Manager according to defined operational procedures to implement the connection of each site with the NRN port. At this stage, any cost issue should be discussed and solved with the NRN involved. In case of difficulties, the GNM-DANTE channel remains the priority means of communication.

The result of the service request process is an activity plan to be performed by the involved parties, identifying action points, resources, timelines and costs. This plan must be accepted by all parties and

is the definition of the project. Contracts between the project and some parties may be signed as a consequence of different policies in resource allocation.

In some cases, the required ATM connection to be provided by one national research network might take long time, might be very expensive or might not be possible to be provided at all. Given that every national connection involves a NRN and an organisation (already connected to the research network), this kind of problems can be considered a national issue and should be solved by the NRN representative and the participant site administrative contact. DANTE's role is to offer co-ordination between parties, and information dissemination. Since each NRN defines its own procedures, there is no guarantee of overall consistency.

In the example, the information needed to evaluate the project feasibility is sent to the responsible person for the ATM network in RENATER, and the Group Network Manager is informed about the procedures in place in UKERNA, the UK national research network. Given that two national networks are involved, acceptance of the project network requirements is the next step. Once RENATER and UKERNA, in the example, have accepted this request, the ATM PVCs are formally requested.

In the network diagram, some other details are known now, and the pieces of the network are fully described to serve as a reference for the implementation process:

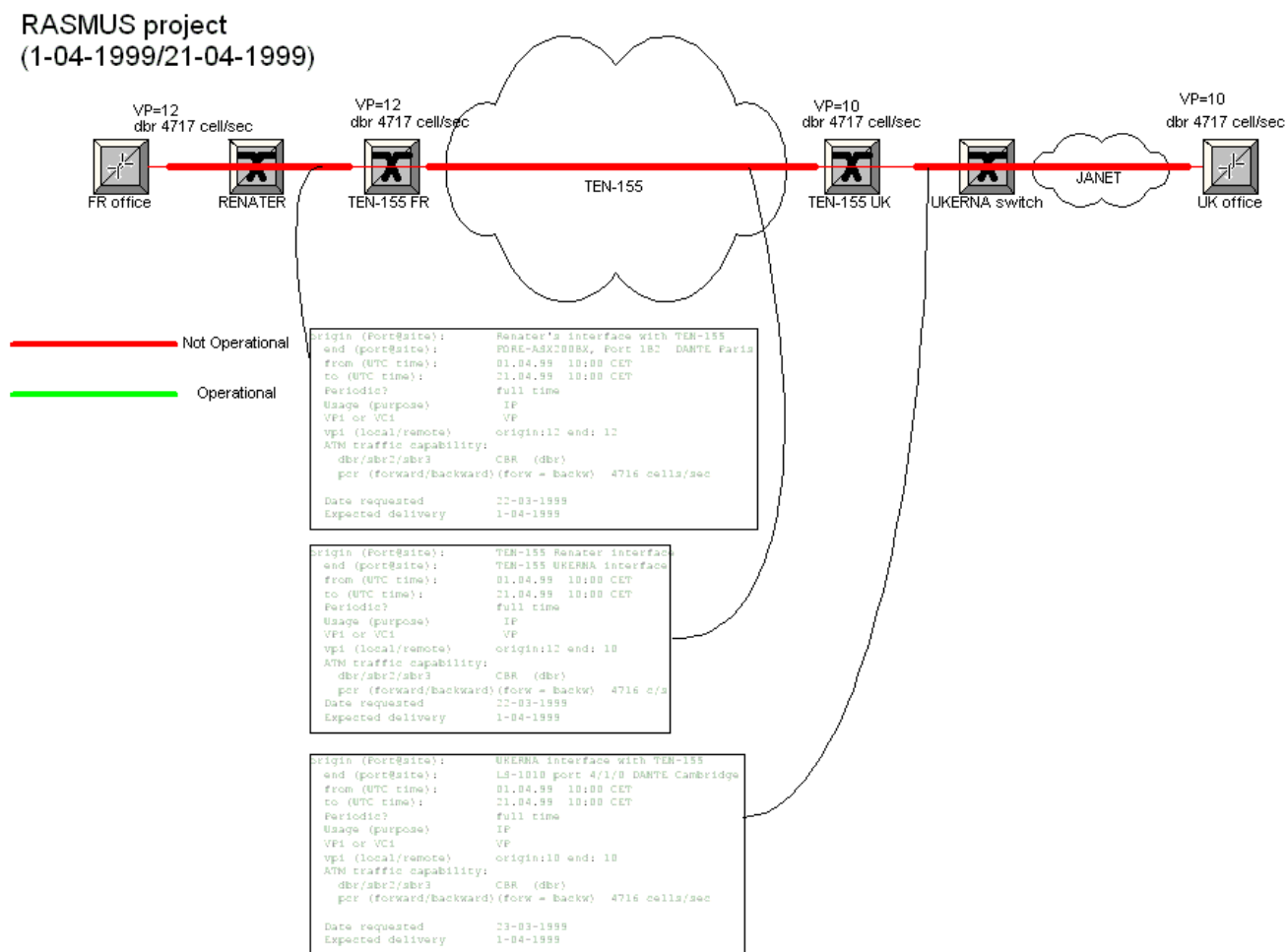

[fig 11] Complete network topology

Delivery stage

Based on the network plan a list of resources to be provided by different organisations, with activation and releasing dates is produced by DANTE and made available to the involved parties, project sites and ASMs. DANTE and the Group Network Manager will track the progress of the delivery of different elements, until everything is delivered and the network is considered operational. An example of available information for project tracking is given in figure 12.

Should problems arise here, they must be solved using the accepted procedures in place or between involved parties. TEN-155 Managed Bandwidth Service depends of the availability of a similar service on a national basis, in those countries connected to TEN-155. Differences in the service offered in different NRN can introduce problems during the MBS process.

Testing of the correct set up of links can be done on a best effort basis, using the equipment in the TEN-155 node to detect traffic generated in the national paths. If IP over ATM is going to be used, basic IP connectivity with equipment in the TEN-155 Point of Presence (POP) can be used for debugging purposes.

Some national research networks offer only a best effort service supported by limited human or technical resources. This must be understood by project participants and accepted as part of the end-to-end TEN-155 managed Bandwidth Service.

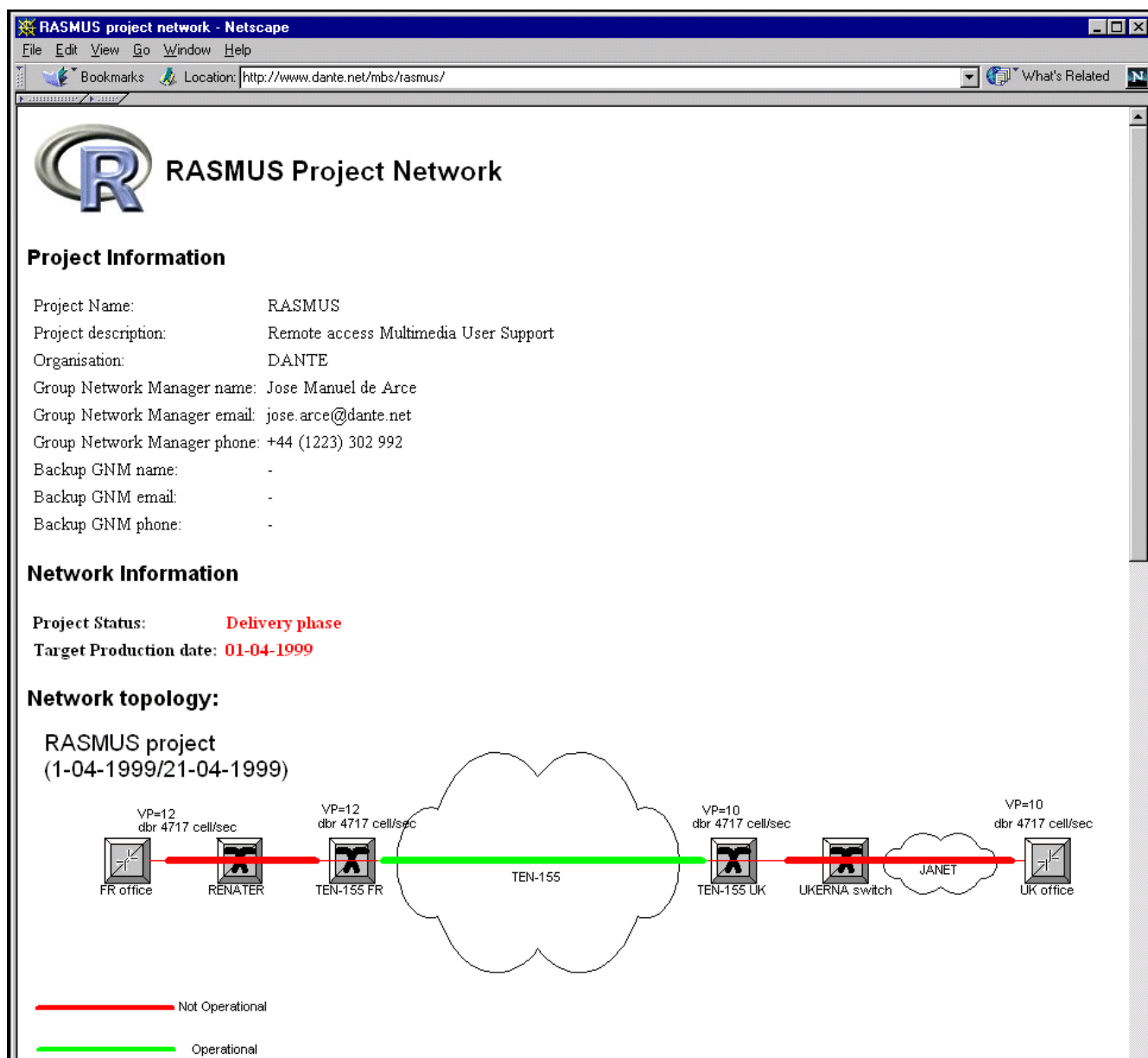

— Not Operational
— Operational

Network Sites:

Site Name	Country	Technical contact information	Administrative contact information
UK Branch, London	UK	Jose Manuel de Arce jose.arce@dante.net +44 1223 302992	same as technical same as technical same as technical
French office, Paris	FR	David Harmelin david.harmelin@dante.net +44 1223 302992	same as technical same as technical same as technical

Network PVCs and Timeslots:

Connection Type	Endpoints	Timeframe	Type	Bandwidth	VPI/VCI at Endpoints
VP	DANTE, Paris Office Renater interface with TEN-155	Scheduled Occasional 01-04-99 10:00 - 21-04-99 24:00 CET	DBR (CBR)	4717 cells/s (2 Mbit/s)	12/12
VP	TEN-155 interface-FR TEN-155 interface-UK	Scheduled Occasional 01-04-99 10:00 - 21-04-99 12:00 CET	DBR (CBR)	4717 cells/s (2 Mbit/s)	12/10
VP	UKERNA interface with TEN-155 DANTE Office Cambridge	Scheduled Occasional 01-04-99 10:00 - 21-04-99 12:00 CET	DBR (CBR)	4717 cells/s (2 Mbit/s)	10/10

Resources status

- The Paris-Renater link was requested on **22-03-1999** and has a expected delivery date of **1-04-1999**
- The TEN-155 link Paris-London was requested on **22-03-1999** and was delivered on **22-03-1999**
- The UKERNA-Cambridge link was requested on **23-03-1999** and has a expected delivery date of **1-04-1999**

For comments or modifications or updates, please contact [Our Help Desk](#)

[fig 12] Project resource tracking information

Production stage

The operational network consists of different segments managed by their correspondent network operations centre. A list of technical contacts for network troubleshooting will be available as part of the network plan for problem debugging and solving.

In those countries where a similar Managed Bandwidth Service exists, local procedures include contact information for problem reporting. DANTE takes the role of co-ordinating network operations for those networks with no similar services and no dedicated Network Operations Center (NOC) resources. The Group Network Manager is the interface between the project network, DANTE, and NRNs with operational Managed Bandwidth Services.

Network outages can be treated by the first organisation noticing them. DANTE will take care of coordinating those problems affecting the project network in TEN-155 and those NRNs without Managed Bandwidth Services dedicated NOC resources. Any network interruption must be reported to DANTE for resolution or forwarding to the corresponding national research network NOC.

The main contact address for reporting problems is: mbs@dante.org.uk, and the telephone number: +44 1223 302992. Service hours are from 9 to 18 GMT.

Changes to the network can be sent by the GNM to DANTE for discussion, following the same principles that produced the operational network during the proposal and agreement stage. Changes will be discussed and agreed by all the involved parties and introduced in production following the agreement phase principles of contacting the responsible person for the network in which the change is going to be made and looking for approval.

Finish Stage

At end of project's life, network resources no longer needed are freed. A final report can be produced describing the network and its usage, as part of the project networking contribution. All project related data can be archived (DAT tapes, CDROM) for future reference.

Acronyms

- **ASM:** ATM Service Manager
- **GNM:** Group Network Manager
- **MBS:** Managed Bandwidth Service
- **NOC:** Network Operations Center
- **NRN:** National Reasearch Network
- **PVC:** Permanent Virtual Connection
- **TEN-155:** Trans European Network, 155 mbits
- **VPN:** Virtual Private Networks

References and URLs

<http://www.dante.net/mbs>

<http://www.dante.net/mbs/nrn/matrix.phtml>